

tenera®

Sheer Shading

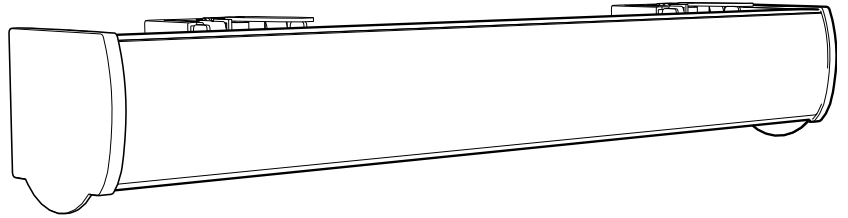

Continuum, Sure-Lift, Cordless, Motorized

Installation Instructions

Thank You

Thank you for choosing your Tenera Sheer Shade
With proper installation and care, your new shades will provide many years of beauty and performance.

Before Installing

Remove shade from the package. Keep all packaging until shade operates to your satisfaction. Contents of your hardware package may vary depending on options chosen.
Additional fasteners may be needed on your specific mounting surface (not included).

Tools Needed

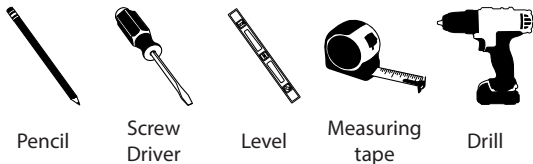

Shade Width	Brackets Required	2-on-1 Headrail
14" - 48"	2	The appropriate number of brackets are provided for each panel.
48 1/8" - 96"	3	
96 1/8" - 120"	4	

Step 1 Space Brackets in Window

Measure 2" in from each end of the headrail and mark the bracket location on the mounting surface.

Space additional brackets evenly between the end brackets. Mark the bracket location on the mounting surface

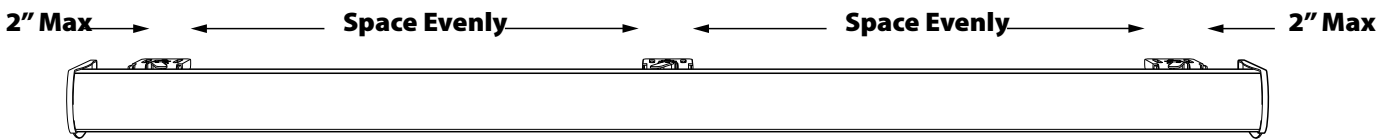

Note: install brackets into studs or headers when possible, and space evenly

Top Limit Stops should be equal distance from the ends of the headrail

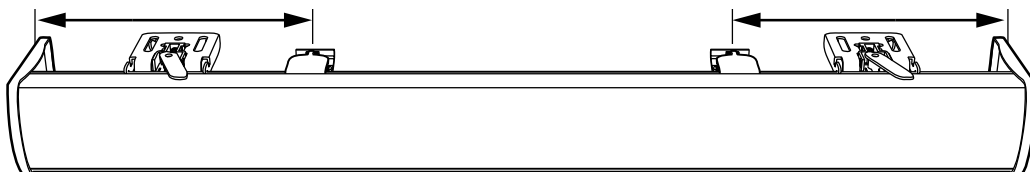

If spacer blocks are being used, place in between mounting surface and bracket before attaching with screws
(Longer screws may be required)

IMPORTANT: Brackets need to be Level and Aligned
Shimming Brackets may be required

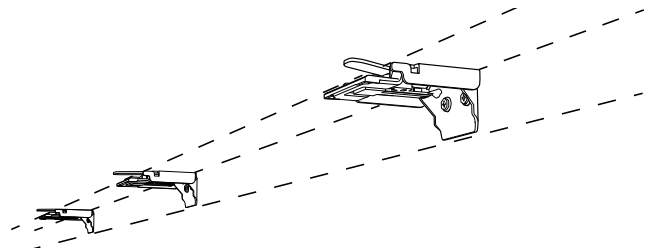

Step 2

Install the Brackets

Use two screws to secure to the mounting surface

INSIDE MOUNT

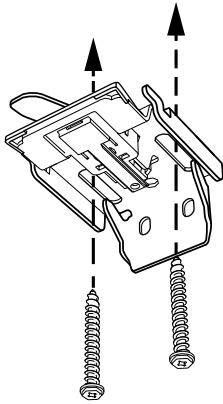

OUTSIDE MOUNT

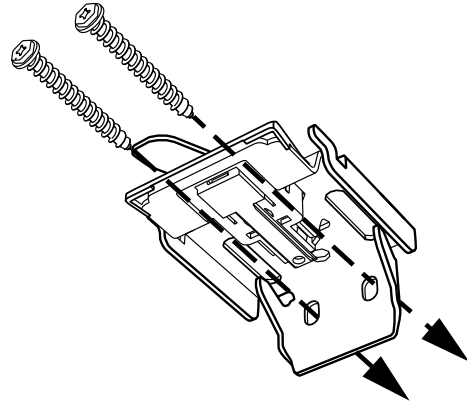

IMPORTANT: Two screws are needed to attach each installation bracket

Extension Brackets (optional)

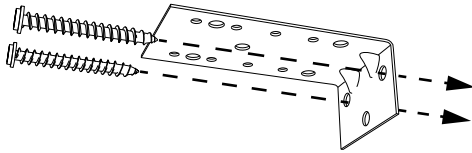

Attach Extension Bracket to the mounting surface using two screws

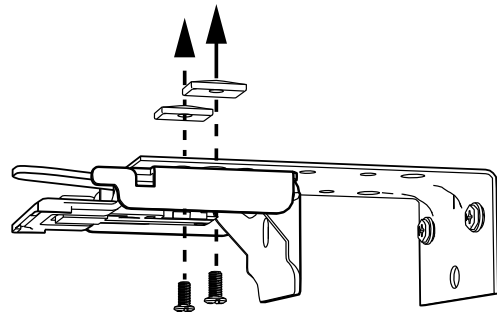

Position Installation Bracket underneath the Extension Bracket and attach using the screws and speed nuts provided

Spacer Blocks (optional)

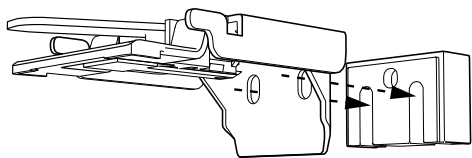

line up holes on Installation Bracket with holes in Spacer Block

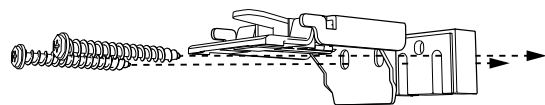

Attach to mounting surface with Screws long enough to go through the Installation Bracket and Spacer Block

IMPORTANT: Brackets need to be Level and Aligned
Shimming Brackets may be required

Step 3 Install the Shade

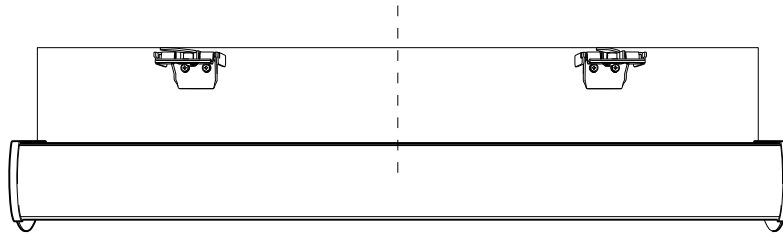

Center Shade with Window Opening

Rest Headrail on the flat piece of the Bracket and under the Arm of the bracket

Using Direct force against each Bracket, push the Headrail into position on Brackets

When the Headrail is fully seated the plastic Bracket Release will snap to the right.

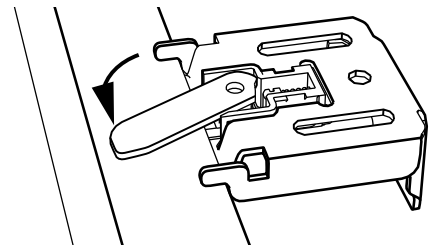
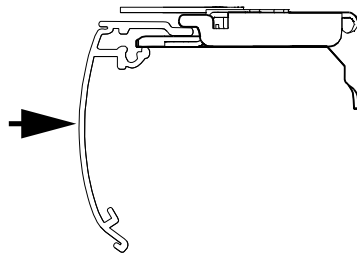
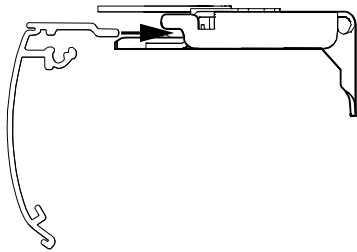

If it is not fully snapped to the right, ensure Headrail is fully seated

Step 4 Operate the Shade

Refer to the Operation Guide supplied with the shade to ensure proper operation. If Shade skews left or right (does not roll straight up) Check that the Headrail is level.

If Headrail is level and the shade still skews, it may require bottom weight adjusting.

Flip up the Bottom Rail of your shade to access the Bottom Rail Weight

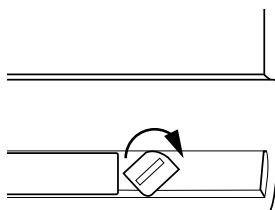
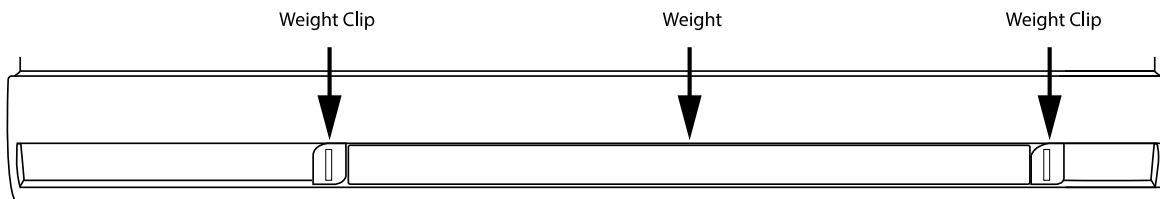

Use a Flat Blade Screwdriver to turn the Weight Clip clock-wise

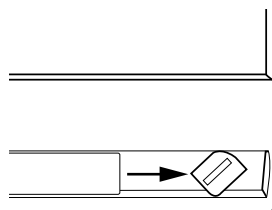

Move Weight Clip down an inch at a time towards the side where fabric is gathering

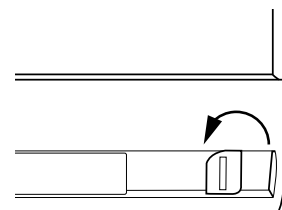

Lock the Weight Clip back into place by turning Counter-Clockwise

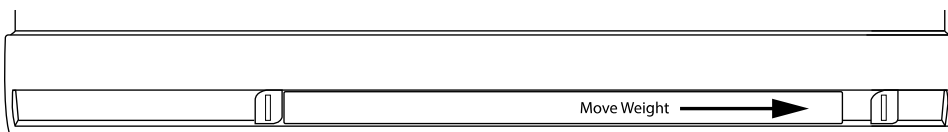

Move weight into new position and lock preceding clip using the same method

Make Sure Headrail is level and test for skewing, repeat as necessary until shade rolls up straight

Step 5 Install Magnetic Hold Down (optional)

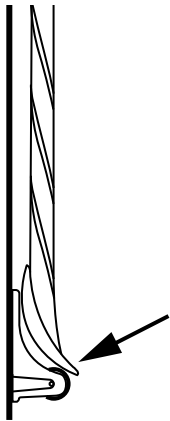

Fully Lower shade and line up the Magnetic Ball of the Hold Down Bracket with the Bottom Rail

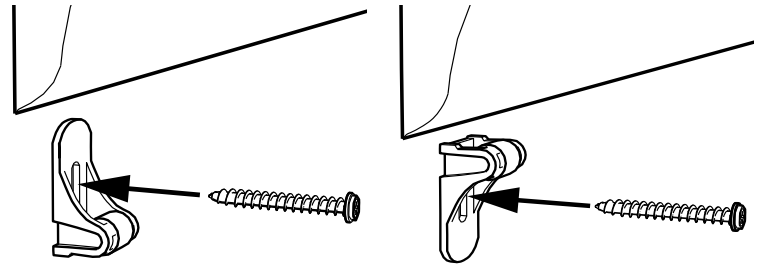

Position the Bracket in your preferred orientation and attach to mounting surface using screws provided

Step 6 Install Dust Cover (optional)

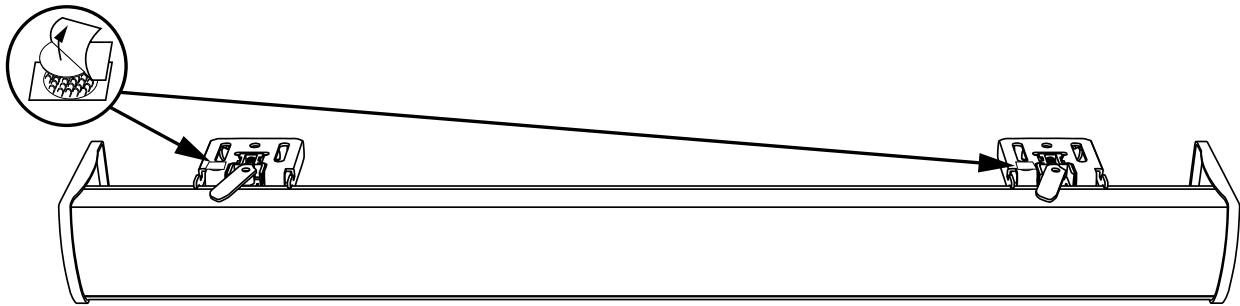

Remove paper backing on one side of the hook and loop fastener dots and apply them on the top of the installation brackets on the ends

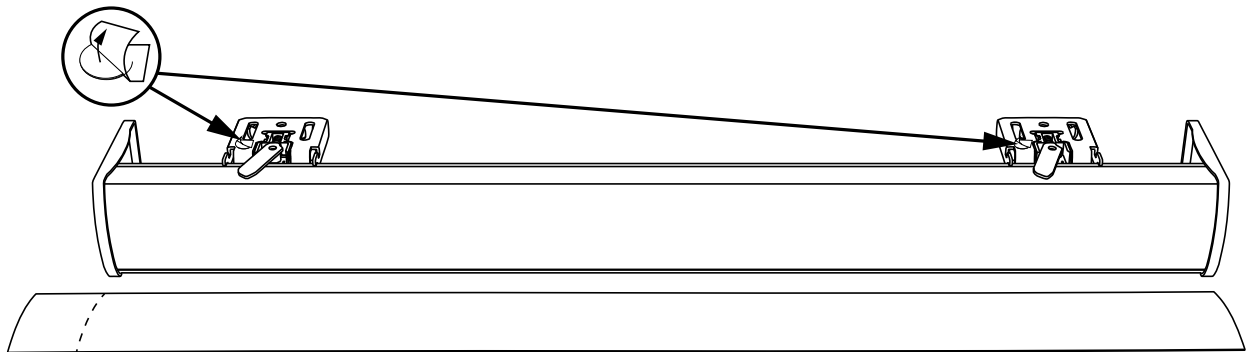

Cut excess off of the dust cover remove the other paper backing on the hook and loop fastener dots

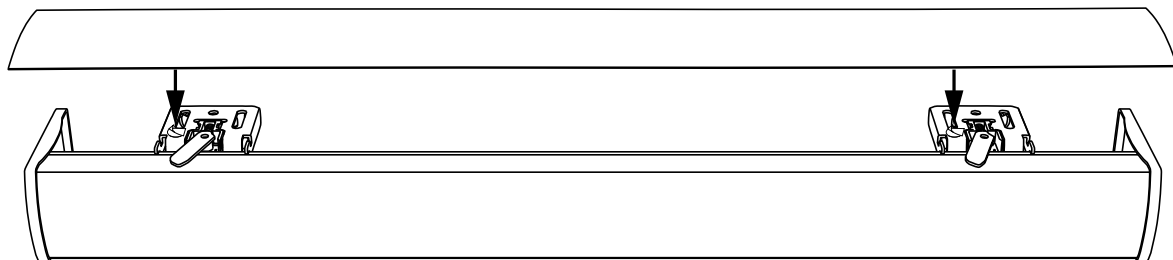

Center the Dust Cover and press down onto the Dots

Step 7 **Install Back Cover** (optional)

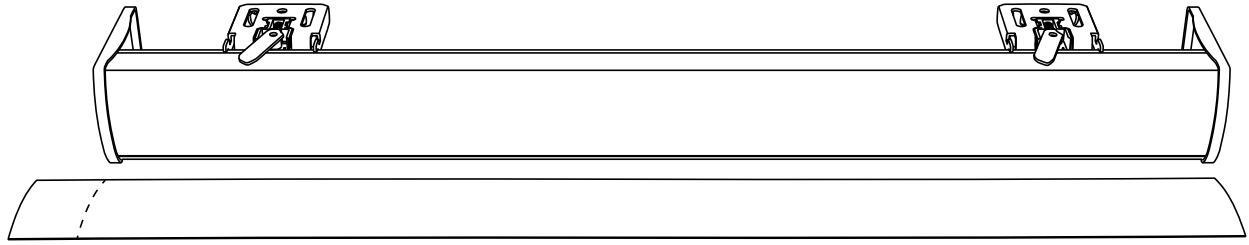

Cut the Back Cover down to size if necessary

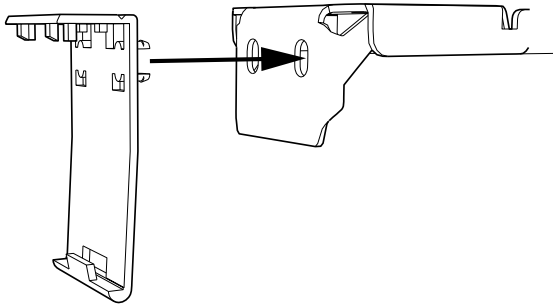

Snap the back cover bracket into the Metal Installation Bracket

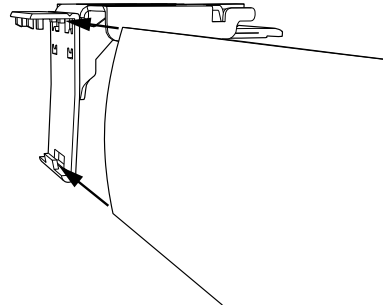

Slide the Back Cover into the Back Cover Brackets

Shade Removal

Raise Shade fully before Removal

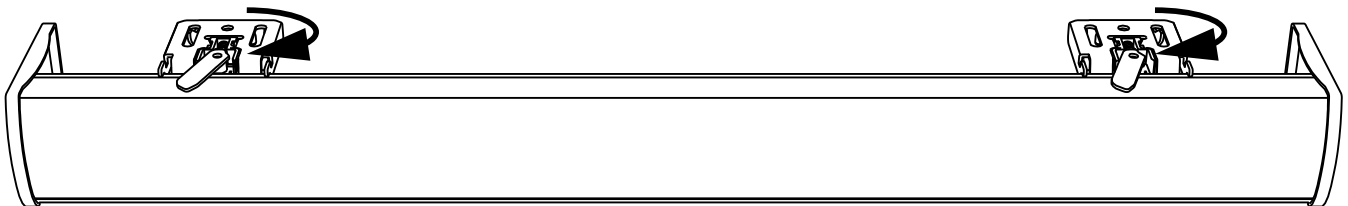

Turn Plastic Release Lever on Installation Bracket to the Left to release the Bracket